



BILLY GOAT VQ VACUUM

Owner's Manual

VQ902SPH, VQ1002SP

Accessories

VACUUM HOSE KIT	HOSE COUPLER KIT	RIDE ON CHARIOT KIT
5" (127mm) x 8' (2.4m) For vacuuming in hard-to-reach areas	5" (127mm) For coupling multiple hoses together to increase vacuuming distance.	Reduces operator fatigue. Operator stands while riding behind vacuum. Maximum load 300 lbs.(136 kg)
P/N 830255	P/N 800334	P/N 830257

Optional Debris bags

STANDARD DEBRIS BAG	DEBRIS BAG COVER	TURF DEBRIS BAG
Standard on VQ models. For dusty conditions.	Directs dust downward away from operator.	For use in leaves and grass in non-dusty conditions.
P/N 830301	P/N 830284	P/N 830313



ABOUT THIS MANUAL

THANK YOU for purchasing a BILLY GOAT® VQ Vacuum. Your new machine has been carefully designed and manufactured to provide years of reliable and productive service. This manual provides complete operating and maintenance instructions that will help to maintain your machine in top running order. Read this manual carefully before assembling, operating, or servicing your equipment.

CONTENTS

SERIAL PLATE DATA AND SPECIFICATIONS _____	3
GENERAL SAFETY _____	4-5
SOUND AND VIBRATION _____	6
INSTRUCTION LABELS _____	7
PACKING CHECKLIST & ASSEMBLY _____	8-9
OPERATION _____	10-11
MAINTENANCE _____	12-13
TROUBLESHOOTING AND WARRANTY PROCEDURE _____	14
MAINTENANCE RECORD _____	15
ILLUSTRATED PARTS & PARTS LISTS _____	16-20



SERIAL PLATE DATA

Record the model number, serial number, date of purchase, and where purchased.

Purchase Date: _____

Purchased From: _____

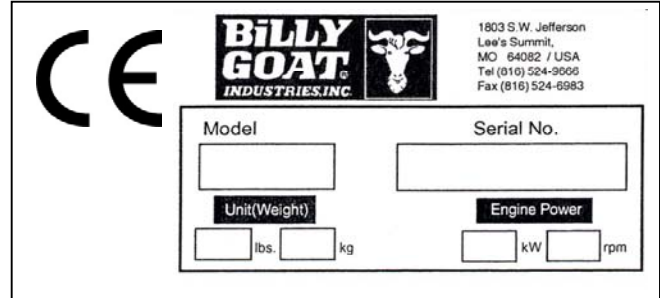

Specifications

	VQ1002SP	VQ902SPH
Engine: HP	10 (7.45 kW)	9.0 (6.6 kW)
Engine: Type	205432-0141	GX270K1QA2
Engine: Fuel Capacity	4 qt. (3.8 L)	6.3 qt. (6.0 L)
Engine: Oil Capacity	0.875 qt. (0.8 L)	1.16 qt. (1.1 L)
Total Unit Weight:	282# (127.9 kg)	287.3# (130.3 kg)
Overall Length	66" (1.68m)	66" (1.68m)
Overall Width	32.75" (0.83m)	32.75" (0.83m)
Overall Height	43.5" (1.10 m)	43.5" (1.10 m)
Max. operating slope	20°	20°
Sound at operators ear	88 dBa	88 dBa
In accordance with 2000/14/EEC	108 dBa	108 dBa
Vibration at operator position	0.83g (8.16m/s ²)	0.92g (9.07m/s ²)

GENERAL SAFETY INSTRUCTIONS and SYMBOLS

The safety symbols shown below are used throughout this manual. You should become familiar with them before assembling, operating, or servicing this equipment.



WARNING: This symbol indicates important information that will prevent injury to yourself or others.



This symbol indicates ear protection is recommended when operating this equipment.



This symbol indicates eye protection is recommended when operating this equipment.



This symbol indicates gloves should be worn when servicing this equipment.



This symbol indicates that this manual and the engine manufacturer's manual should be read carefully before assembling, operation, or servicing this equipment.



CAUTION: This symbol indicates important information that will prevent damage to your BILLY GOAT® VQ Vacuum.



This symbol indicates the engine oil level should be checked before operating this equipment.

Read and make sure you thoroughly understand the following safety precautions before assembling, operating or servicing this equipment:



READ this manual and the engine manufacturer's manual carefully before assembling, operating, or servicing this equipment.



EAR PROTECTION is recommended when operating this equipment.



EYE PROTECTION is recommended when operating this equipment.



BREATHING PROTECTION is recommended when operating this equipment.



WARNING: **EXHAUST** from this product contains chemicals known to the State of California to cause cancer, birth defects or other reproductive harm.

DO NOT operate this equipment on any unimproved forested, brushy, or grass covered land unless a spark arrester is installed on the muffler as required by Section 4442 of the California Public Resources Code. The arrester must be maintained in good working order. Other states may have similar laws. Federal laws apply on federal lands.

DO NOT run engine in an enclosed area. Exhaust gases contain carbon monoxide, an odorless and possibly fatal poison.





VQ Owner's Manual





WARNING:  **DO NOT** run this equipment indoors or in any poorly ventilated area. Refueling outdoors is recommended.

 **DO NOT** refuel this equipment while the engine is running. Allow engine to cool for at least two minutes before refueling.

 **DO NOT** store gasoline near an open flame.

 **DO NOT** remove gas cap while engine is running.

 **DO NOT** start or operate engine if strong odor of gasoline is present.

 **DO NOT** start or operate engine if gasoline is spilled. Move equipment away from spill until gasoline has completely evaporated.

 **DO NOT** smoke while filling the fuel tank.

 **DO NOT** check for spark with spark plug or spark plug wire removed. Use an approved spark tester.

 **DO NOT** operate engine without a muffler. Inspect muffler periodically and replace if necessary. If equipped with muffler deflector, inspect deflector periodically and replace if necessary.

 **DO NOT** operate engine with grass, leaves or other combustible material near the muffler.

 **DO NOT** touch muffler, cylinder, or cooling fins when hot. Contact with hot surfaces may cause severe burns.

 **DO NOT** leave equipment unattended while in operation.

 **DO NOT** park equipment on a steep grade or slope.

 **DO NOT** operate equipment with bystanders in or near the work area.

 **DO NOT** allow children to operate this equipment.

 **DO NOT** operate equipment with guards removed.

 **DO NOT** operate equipment near hot or burning debris or any toxic or explosive materials.

 **DO NOT** operate equipment on slopes greater than specified in Specifications section of this manual.

 **DO NOT** place hands or feet underneath unit, or near any moving parts.

ALWAYS remove spark plug wire when servicing equipment to prevent accidental starting.

ALWAYS check fuel lines and fittings frequently for cracks or leaks. Replace if necessary.

ALWAYS keep hands and feet away from moving or rotating parts.

ALWAYS store fuel in approved safety containers.



WARNING: Important

Remove all rocks, wire, string, plastic bags, etc. that can present a hazard during work prior to starting.



DO identify and mark all fixed objects to be avoided during work such as sprinkler heads, water valves, or clothes line anchors, etc.



VQ Owner's Manual

SOUND



SOUND LEVEL 88 dB(a) at Operator Position

Sound tests were conducted in accordance with 2000/14/EEC, and were performed on 2-14-2002 under the conditions listed below.

 Sound power level listed is the highest value for any model covered in this manual. Please refer to serial plate on the unit for the sound power level for your model.

General Conditions:	Sunny
Temperature:	50°F (10°C)
Wind Speed:	15 mph (24.1 kmh)
Wind Direction:	North
Humidity:	32%
Barometric Pressure:	30.06" Hg (764 mm Hg)

VIBRATION DATA

VIBRATION LEVEL 0.92g (9.07m/s²)

Vibration levels at the operator's handles were measured in the vertical, lateral and longitudinal directions using calibrated vibration test equipment. Tests were performed on 5-25-2006 under the conditions listed below.

General Conditions:	Sunny
Temperature:	75°F (24.1°C)
Wind Speed:	6.7 mph (10.8kph)
Wind Direction:	West
Humidity:	52.5%
Barometric Pressure:	29.9Hg (101.3kpa)

INTENDED USE

INTENDED USE: This machine is designed for vacuuming leaves, grass clippings and other types of organic litter. Debris mixed with cans, bottles and small amounts of sand can be vacuumed; however, it is not this machine's primary purpose. Vacuuming cans, bottles and sand will affect the longevity of your machine. Self propelled unit is not intended for use with any ground engaging implements [maximum tow bar weight 300 lbs (136 kg)].

Do not operate if excessive vibration occurs. If excessive vibration occurs, shut engine off immediately and check for damaged or worn impeller, loose impeller bolt, loose impeller key, loose engine or lodged foreign objects.

Note: See parts list for proper impeller bolt torque specifications. (page 18).

INSTRUCTION LABELS

The labels shown below were installed on your BILLY GOAT® VQ Vacuum. If any labels are damaged or missing, replace them before operating this equipment. Item numbers from the Illustrated Parts List and part numbers are provided for convenience in ordering replacement labels. The correct position for each label may be determined by referring to the Figure and Item numbers shown.



LABEL DANGER KEEP HANDS AND FEET AWAY
ITEM #100 P/N 400424



LABEL EAR EYE BREATHING ITEM #180
P/N 890254



DANGER FLYING DEBRIS
ITEM #101 P/N 810736



LABEL READ MANUAL
ITEM #181 P/N 890301



LABEL EXPLOSIVE FUEL
ITEM # 130 P/N 400268

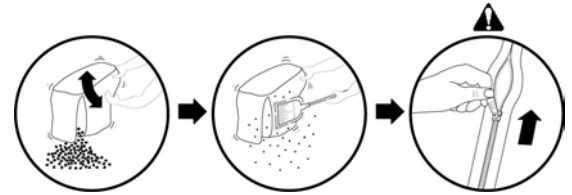

DEBRIS BAG LABEL



LABEL DANGER GUARDS
ITEM #111 P/N 900327



LABEL OIL CHAIN
ITEM #111 P/N 830502



LABEL CAUTION
ITEM #159
P/N 830138



LABEL DIVERTOR INSTRUCTIONS
ITEM #99 P/N 830196



LABEL CLUTCH VQ
ITEM #106 P/N 830503

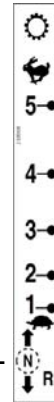

LABEL SPEED CONTROL
ITEM #150 P/N 830237

Throttle Control

Briggs and HONDA engines have a choke type carburetor that is operated using choke lever on side of engine.

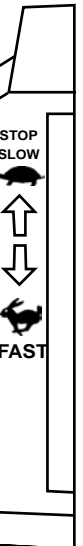

ENGINE LABELS

HONDA

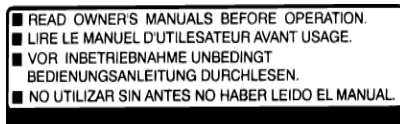

BRIGGS & STRATTON

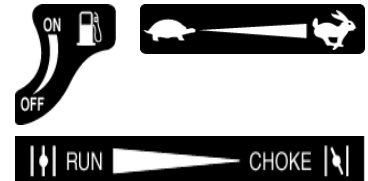



PACKING CHECKLIST

Your Billy Goat is shipped from the factory in one carton, completely assembled except for the debris bag, deflector assy, upper handle assembly, rod nozzle door, and elbow assy.



READ all safety instructions before assembling unit.

TAKE CAUTION when removing the unit from the box the Handle Assembly is attached by cables and folded over



PUT OIL IN ENGINE BEFORE STARTING

PARTS BAG & LITERATURE ASSY

Warranty card P/N- 400972, Owner's Manual P/N-830542, Declaration of Conformity P/N-830321.

Boxing Parts Checklist







- Debris Bag P/N-890301
- Elbow Assy P/N-830159

Upper Handle Assy Per model

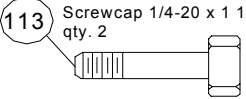
- Briggs models P/N-830011
- Honda models 830012

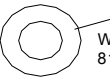
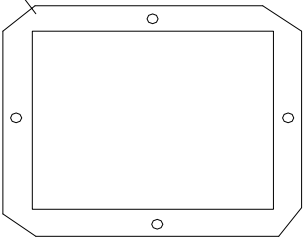
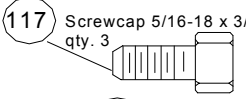
- Deflector Assy P/N-830280
- Rod Door Nozzle P/N-830286
- Literature Assy P/N-830531
- Honda 9 HP GX270
- Briggs & Stratton 10 HP Intek

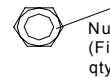
Parts Bag Assembly Checklist P/N 830204

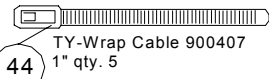
<p>113 Screwcap 1/4-20 x 1 1/4 qty. 2</p> 	<p>131 Nut Lock 1/4-20 8160001 qty. 2</p> 	<p>143 Washer 1/4 Flat Cut 8171002 qty. 6</p> 	<p>44 Gasket Flange Transition VQ P/N 830160 (not to scale)</p> 
<p>117 Screwcap 5/16-18 x 3/4 qty. 3</p> 	<p>132 Nut Lock 5/16-18 8160002 qty. 3</p> 	<p>138 Nut Regular 5/16-24 (Fine Thread) 8149002 qty. 2</p> 	
<p>73 Rod End Ball Joint 5/16-24 400873 qty. 2</p> 	<p>140 Washer 5/16 SAE 8172008 qty. 3</p> 	<p>44 TY-Wrap Cable 900407 1" qty. 5</p> 	

ASSEMBLY

1. **UPPER HANDLE (item 41).** Assemble securely to lower handle stubs (item 37) and handle brace (item 36), using screws (item 120 & 121), so that screw heads are on inside of handle. Otherwise, premature bag wear could result.
2. **NOZZLE DOOR CONTROLS.** Assemble ball joints (item 73), jam nuts (item 138), to both ends of rod (item 47). *Do not fully tighten jam nuts.*
Using screw (item 113), washer (item 143) and lock nut (item 131), connect one end of rod (item 47) to nozzle door mounting. (See Figure 5). Using rod, pull nozzle door open horizontal to ground and hold opposite end of rod next to mounting hole on remote lever (item 48), already assembled onto upper handle. (See Figure 1). If necessary, adjust rod length using threads provided on rod. Adjust rod length to give a minimum of 1.0" (25.4 mm) hand clearance between lever & maximum forward throttle position when door is open. Assemble upper end of rod to lever on handle using same hardware item numbers as shown above. (See figure 1 & 2). Tighten jam nuts.
3. **EXHAUST ASSY.** Place flange gasket (item 35) onto housing of main unit and assemble **exhaust elbow** to housing using screws (item 117), washers (item 140) and lock nuts (item 132), provided in parts bag. The rear hole mounts deflector (item 118), using screw assembly (already attached to deflector) and lock nut (item 132). Bend opposite end of deflector down until notch in rear of deflector catches onto handle brace (item 36) (see figure 3).
4. **DEBRIS BAG (Item 50)** (see figure 4).
 - 4.1 Unfold and place mouth of bag over exhaust elbow, completely covering the discharge opening with bag neck straps, placing one on each side of elbow flange.
COMPLETELY TIGHTEN BAG NECK STRAPS
 - 4.2 Attach rear hanger straps of bag to the hanger loops located one on each side of the upper handle.
5. **CABLES AND WIRES.** Attach to the handle using cable clamps (item 44).
6. Secure engine starter rope into starter rope guide (Item 177) using hardware that is preassembled to the lower handle.
7. **INSPECT ALL PARTS & MECHANICAL FASTENERS** for security and integrity.
8. **Note:** See debris bag conditioning under operation section on page 11).

SELF PROPELLED ONLY (before starting unit).

9. **CONTROL ASSY (item 77).**
Before starting engine, check for neutral by placing the control into neutral and engaging the bail, the unit has been adjusted at the factory and should free wheel. If not, adjust as needed by placing the control (item 77) and transmission offset link (item 68) into neutral and adjust nuts on control cable (item 75).
10. Check tire pressure and lubricate all grease and oil points (see MAINTENANCE).
11. Connect spark plug wire.

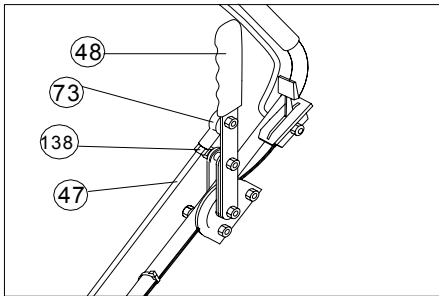

Fig. 1

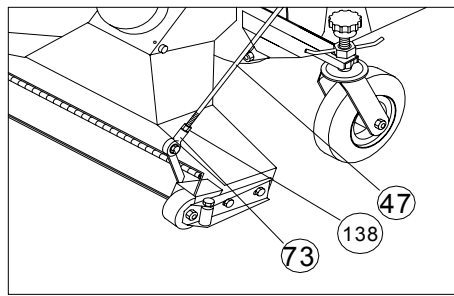

Fig. 2

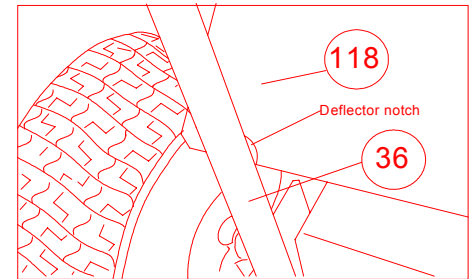

Fig. 3

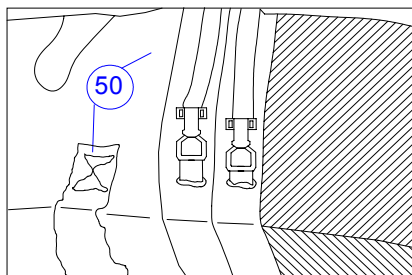

Fig. 4

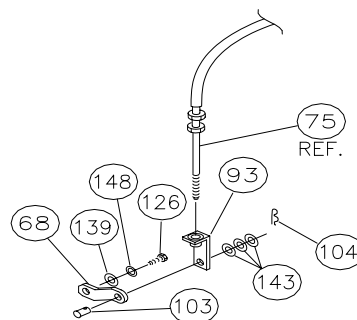



Fig. 5



OPERATION

 Like all mechanical tools, reasonable care must be used when operating machine.

Inspect machine work area and machine before operating. Make sure that all operators of this equipment are trained in general machine use and safety.

 **PUT OIL IN ENGINE BEFORE STARTING**

STARTING

 **ENGINE:** See engine manufacturer's instructions for type and amount of oil and gasoline used. Engine must be level when checking and filling oil and gasoline.

ENGINE SPEED: Controlled by throttle lever on left side of handle. Under normal conditions operate at minimum throttle to accomplish your current cleaning task. For Honda model, the stop switch is located on the switch panel on the engine & for SP Honda models only, on remote shift control panel. NOTE: Before starting, check that all switches and fuel valves are on.

FUEL VALVE: Move fuel shutoff valve to "ON" position.

CHOKE: Located on engine. Choke engine before starting when engine is cold.

THROTTLE: Move remote throttle control to fast position. Pull starting rope to start engine.

IF YOUR UNIT FAILS TO START:

See Troubleshooting on page 16.

HANDLING & TRANSPORTING:

 Do not lift by hand. Use loading ramps or other mechanical assistance. Secure in place during transport. See page 3 for weight specifications

 Never lift the machine while the engine is running.

STORAGE

 Never store engine indoors or in enclosed poorly ventilated areas with fuel in tank, where fuel fumes may reach an open flame, spark or pilot light, as on a furnace, water heater, clothes dryer or other gas appliance.

If engine is to be unused for 30 days or more, prepare as follows:

 Remove all gasoline from carburetor and fuel tank to prevent gum deposits from forming on these parts and causing possible malfunction of engine. Drain fuel outdoors, into an approved container, away from open flame. Be sure engine is cool. Do not smoke. Run engine until fuel tank is empty and engine runs out of gasoline.



NOTE: Fuel stabilizer (such as Sta-Bil) is an acceptable alternative in minimizing the formation of fuel gum deposits during storage. Add stabilizer to gasoline in fuel tank or storage container. Always follow mix ratio found on stabilizer container. Run engine at least 10 min. after adding stabilizer to allow it to reach the carburetor.

VACUUMING OPERATION

VACUUM NOZZLE HEIGHT ADJUSTMENT: Is adjusted by unlocking wing nut (item 32) and turning caster knob. Turning the knob clockwise increases height. Be sure the nozzle height is level (left to right) before tightening caster wing nuts. Adjust nozzle height according to surface conditions and debris size; For vacuuming on flat surfaces, set nozzle 1/2" (12.7 mm) to 5/8" (15.8 mm) above ground; Higher for uneven terrain and turf. **Note: The nozzle side bogie wheels should be at least 1/8" (3.2mm) above the ground, or maneuverability will be reduced.**

FOR MAXIMUM PICKUP: Adjust nozzle close to debris, but without blocking airflow into the nozzle.

NOTE: Never bury nozzle into debris.

  **CLEARING A CLOGGED NOZZLE & EXHAUST:** Turn engine off and wait for impeller to stop completely and disconnect spark plug wire. Wearing durable gloves, remove clog. **Danger,** the clog may contain sharp materials. Reconnect spark plug wire.

NOZZLE GOBBLER DOOR.

Large debris can be vacuumed without readjusting nozzle height by temporarily opening the remote **Nozzle Gobbler Door.** For maximum pickup of small debris, the gobbler door must be down, flush with front face of nozzle.



DEBRIS BAG

Debris bags are normal replaceable wear items.

Note: *Frequently empty debris to prevent bag overloading with more weight than you can lift.*

An optional bag and dust cover is available for use where debris will be vacuumed in dusty conditions (See **Optional Accessories** shown on page 1.)

DO NOT place bag on or near hot surface, such as engine. Run engine at 1/2 throttle for first 1/2 hour to condition new bag. Your new bag requires a break-in period to condition the pores of the material against premature blockage. The entire bag surface serves as a filter, and must be able to breath to have good vacuum performance. Be sure engine has come to a complete stop before removing or emptying bag.

This vacuum is designed for picking up trash, organic material and other similar debris (see Safety Warnings page 4-5).

However, many vacuums are used where dust is mixed with trash. Your unit can intermittently vacuum in dusty areas. Dust is the greatest cause of lost vacuum performance. However, following these rules will help maintain your machine's ability to vacuum in dusty conditions:

- Run machine at idle to quarter throttle.
 - The debris bag must be cleaned more frequently. A vacuum with a clean, pillow soft bag will have good pickup performance. One with a dirty, tight bag will have poor pickup performance. If dirty, empty debris and vigorously shake bag free of dust.
 - Machine or pressure-wash debris bag if normal cleaning does not fully clean bag. Bag should be thoroughly dry before use.
- Having one or more spare debris bags is a good way to reduce down time while dirty bags are being cleaned.*
- DO NOT** leave debris in bag while in storage.

PROPULSION

PROPULSION: VQ self-propelled vacuums are equipped with 5 forward gears, neutral and reverse. With the engine running, the bail in released position and brake in on position, select desired drive gear. Pull bail against handle to engage drive (see figure 7). Smoothly engage the bail. Parking brake engages when the bail is released. To freewheel, set transmission control in neutral and pull back on bail. Use good judgment when operating the self-propelled drive. Fifth gear is faster than walking speed and should normally be used only for moving quickly from place-to-place. Using neutral, on level terrain is advisable when maneuvering in tight areas. This increases operator control, and can prevent bumping into nearby objects. Do not force-shift gears of transmission. To assist gear meshing, it may be necessary to partially engage bail while shifting. To stop machine, release operator's bail (this engages the parking brake). Do not shift the transmission while unit is moving. Internal damage to transmission can result

For reverse - Set Throttle to Idle

With operator's bail released, pull shift lever back and depress wire stop (item 90) to continue to the reverse position. Then smoothly pull operator's bail against handle. Release bail to stop (see fig 7).

 Drive Gear selection @ (3400 RPM)							
Position	Rev.	N	1	2	3	4	5
MPH	3.0	0	1.9	2.7	3.4	4.0	5.1
KPH	4.8	0	3.1	4.4	5.5	6.5	8.3

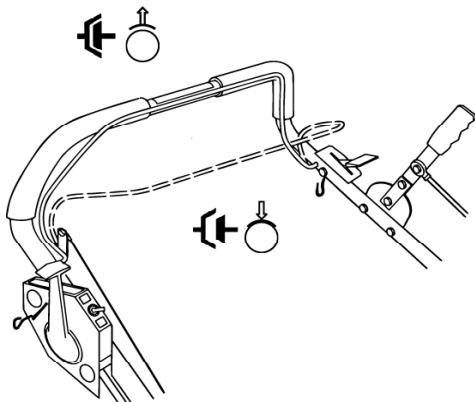

Fig. 7



MAINTENANCE

PERIODIC MAINTENANCE

Periodic maintenance should be performed at the following intervals:

Maintenance Operation	Every Use (daily)	Every 5 hrs (daily)	Every 10 Hrs	Every 25 Hrs	Every 50 Hrs
Inspect for loose, worn or damaged parts.		•			
Clean Debris bag and check strap tightness	•				
Check Tire pressure	•			•	
Engine (See Engine Manual)					
Check for excessive vibration		•			
Check belt adjustment (pg. 15)					•
Grease wheel zerks					•
Lubricate Drive chain and oil control pivot points			•		

IMPELLER REMOVAL

1. Disconnect spark plug wire.
2. Disconnect remote control rod from nozzle gobbler door.
3. Elevate front of machine using stable support blocks between housing and ground so that front caster wheels are not touching ground.
4. Remove nozzle and caster wheel brackets from the housing.
5. Remove both the top and side belt guards between housing and transmission.
6. Loosen wire belt guide located on front face of engine on left side of unit between housing and engine.
7. Slide belt toward engine, out of belt groove in impeller hub drive pulley.
8. Remove impeller bolt and lock washer.
9. If impeller slides off freely, proceed to (step 12). **(Do not drop impeller).**
10. If impeller does not slide off crankshaft, place two crowbars between impeller and housing on opposite sides. Pry impeller away from engine until it loosens. *Using a penetrating oil can help loosen a stuck impeller.*
11. If the impeller cannot be loosened, obtain a 1" (25.4mm) longer bolt of the same diameter and thread type as the impeller bolt. Invert engine and impeller and support engine above ground to prevent recoil damage. Thread longer bolt by hand into the crankshaft until bolt bottoms. Using a suitable gear or wheel puller against the bolt head and the impeller back-plate (near the blades), remove impeller from shaft.
12. Slide impeller off of crank shaft and remove impeller from housing.
13. Reinstall new impeller and all applicable spacers, new impeller bolt and lockwasher in reverse order of removal. *(See the parts drawing on pages 16 and 17 for parts break-down and parts list on page 18 for proper impeller bolt torque specifications and proper spacer for Honda engine only.)*
14. When impeller is installed, slide belt into drive pulley and adjust wire belt guide as shown on page 13 (see fig. 10 & 11).
15. Reattach nozzle and both caster brackets in reverse order of removal.
16. Check operator's bail to ensure that it operates properly. (If not, see drive adjustments on page 13). *Note: Drive must completely disengage with bail released and must engage when bail is depressed within 1.0" (25.4mm) of the operator's handle.*
17. Reinstall all belt guards.
18. Reconnect spark plug wire.

-  **Chain Lubrication:** Using S.A.E. 30 weight oil or equivalent. See maintenance schedule.
- Grease:** Wheels, Casters, and Rear Axle Bearings.
- Tire air pressure:** Check at regular intervals & maintain:
Rear SP 13" tires at **14 psi.** (9.8 kPa).

DRIVE

Chains and Belts are normal replaceable wear items. A new chain should not be used on worn sprockets. Sprockets should be replaced when replacing chains.

MAINTENANCE

Brake Adjustment: As parking brake wears, the brake discs may eventually require adjustment. To adjust belt, remove brake guard and tighten mounting nut that connects brake arm onto transmission. Adjust cable as required. Unit must freewheel with brake off. **DO NOT OVER ADJUST.**

CHAIN ADJUSTMENTS (see pg. 17)

1. Remove guards and place a support underneath the back end of the machine to raise the back wheels off of the ground.
2. Inspect chain and sprockets for wear, lubrication and tension. Replace if badly worn or damaged.

CHAIN TENSION AND ALIGNMENT (see pg. 17)

3. To install a new chain, locate and remove the keeper clip of chain connecting link on inboard side of chain. Along with the master link and remove the chain. Replace chain, master link and keeper clip. Make sure the open end of the clip is facing away from the chain travel and that the clip is on the inboard side of the unit.
4. Check the alignment of the chain to ensure that the chain will not jump off of the sprockets by rotating the wheels while they are off the ground. If the chain is aligned properly proceed to step 8.
5. Alignment is made by loosening the nuts on the rear wheel bearings, do not remove bearing carriage bolts, nuts or wheels.
6. With the bearings pressed fully outward against wheels, keeping axle square with engine base, align and tension chain for proper travel in as straight a line as possible. When the desired position is reached, slightly tighten front bearing bolts and nuts first. Then slightly tighten rear bearings. (Note: Tightening the front bearing carriage bolts and nuts first, helps keep chain tight.)
7. Recheck chain alignment, tension and axle squareness. If ok, fully tighten front and then rear bearing screws. Repeat adjustment steps if necessary.
8. Check chain tension and roll wheels to be sure there are no excessively tight areas in the chain. Readjust if necessary.
9. Reinstall chain guard and differential guard.
10. Reinstall spark plug wire.

Belt Adjustment: As V-belt wears, adjustments may be required. Adjust by tightening or by loosening clutch cable nut as required. When replacing the belt, the impeller must be removed. See instructions on page 12. See parts list for impeller bolt torque specifications. See figure 10 & 11 for proper belt tension adjustment. If cable cannot be adjusted to provide proper belt tension then belt must be replaced. **DO NOT OVER ADJUST.**

Chain Lubrication: With machine not running, oil chain using general S.A.E. 30 weight oil or chain lube every 10 hours or as needed. Chain oiling hole is located in rear axle cover. Note: Be sure that entire length of chain is properly oiled. Oiling only a few positions in the chain rotation will not properly oil the chain.

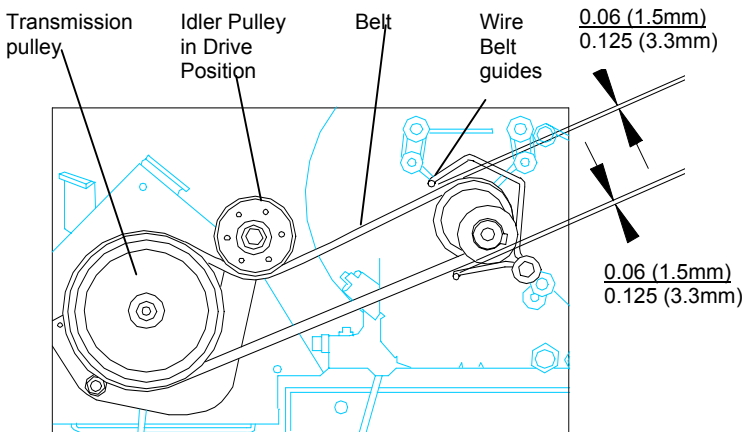

Engaged drive position: Wire belt guides should clear belt by 0.06" - 0.125" (1.5mm - 3.3mm)

Fig. 10

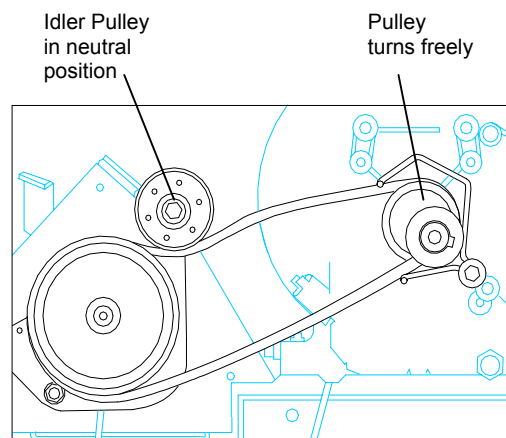

Neutral position

Fig. 11



Troubleshooting

Problem	Possible Cause	Solution
Abnormal vibration.	· Loose or out of balance impeller or loose engine	· Check impeller and replace if required. Check engine
Will not vacuum or has poor vacuum performance	· dirty debris bag. Nozzle height set too high or low. Hose kit cap missing. Clogged nozzle or exhaust. Excessive quantity of debris.	· Clean debris bag. Shake bag clean or wash. Adjust nozzle height. Check for hose kit cap. Unclog nozzle or exhaust. Allow air to feed with debris
Engine will not start.	· Stop switch off. Throttle in off position. Engine not in full choke position. Out of gasoline. Bad or old gasoline. Sparkplug wire disconnected. Dirty air cleaner. Low oil (honda only)	· Check stop switches, throttle, choke position and gasoline. Connect spark plug wire. Clean or replace air filter. Or contact a qualified service person.
Engine is locked, will not pull over.	· Debris locked in impeller. Engine problem.	· See page 10. Contact a engine service dealer for engine problems
Nozzle scrapes ground in lowest height setting.	Nozzle height out of adjustment	Adjust nozzle height (See Nozzle height fine adjustment for hard surfaces on page 10
No self propelling	Transmission not in gear. Operator's bail not engaging belt or out of adjustment. Worn out, broken, or mispositioned belt.	Check transmission gear selection. Check bail cable adjustment and belt and chain (see pg. 13
Self propelled drive will not release	Sticking belt idler arm. Belt fingers out of adjustment, bent or broken. Parking brake adjusted too tight	Check idler. Idler arm mounting screw may be too tight or loose. Check wire belt guide adjustment. Replace if broken. (see fig 10 & 11 adjustment on pg 13.
Noisy or broken chain	No chain lubrication. Chain out of alignment or over tensioned.	See Chain adjustment on pg. 13.

When servicing engine refer to specific manufacturers engine owner's manual. Engine warranty is covered by the specific engine manufacturer. If your engine requires warranty or other repair work contact your local servicing engine dealer. When contacting a dealer for service it is a good idea to have your engine model number available for reference (See table page 3). If you cannot locate a servicing dealer in your area you can contact the manufacturers national service organization.

To reach:

American Honda: 800-426-7701

Briggs & Stratton: 800-233-3723

WARRANTY CLAIM PROCEDURE

Should a BILLY GOAT[®] machine fail due to a defect in material and/or workmanship, the owner should make a warranty claim as follows:

- The machine must be taken to the dealer from whom it was purchased or to an authorized Servicing BILLY GOAT Dealer.
- The owner must present the remaining half of the Warranty Registration Card, or, if this is not available, the invoice or receipt.
- The Warranty Claim will be completed by the authorized BILLY GOAT Dealer and submitted to their respective BILLY GOAT Distributor for their territory Attention: Service Manager. Any parts replaced under warranty must be tagged and retained for 90 days. The model number and serial number of the unit must be stated in the Warranty Claim.
- The distributor service manager will sign off on the claim and submit it to BILLY GOAT for consideration.
- The Technical Service Department at BILLY GOAT will study the claim and may request parts to be returned for examination. BILLY GOAT will notify their conclusions to the distributor service manager from whom the claim was received.
- The decision by the Technical Service Department at BILLY GOAT to approve or reject a Warranty Claim is final and binding.

For online product registration go to www.billygoat.com



PARTS DRAWING VQ

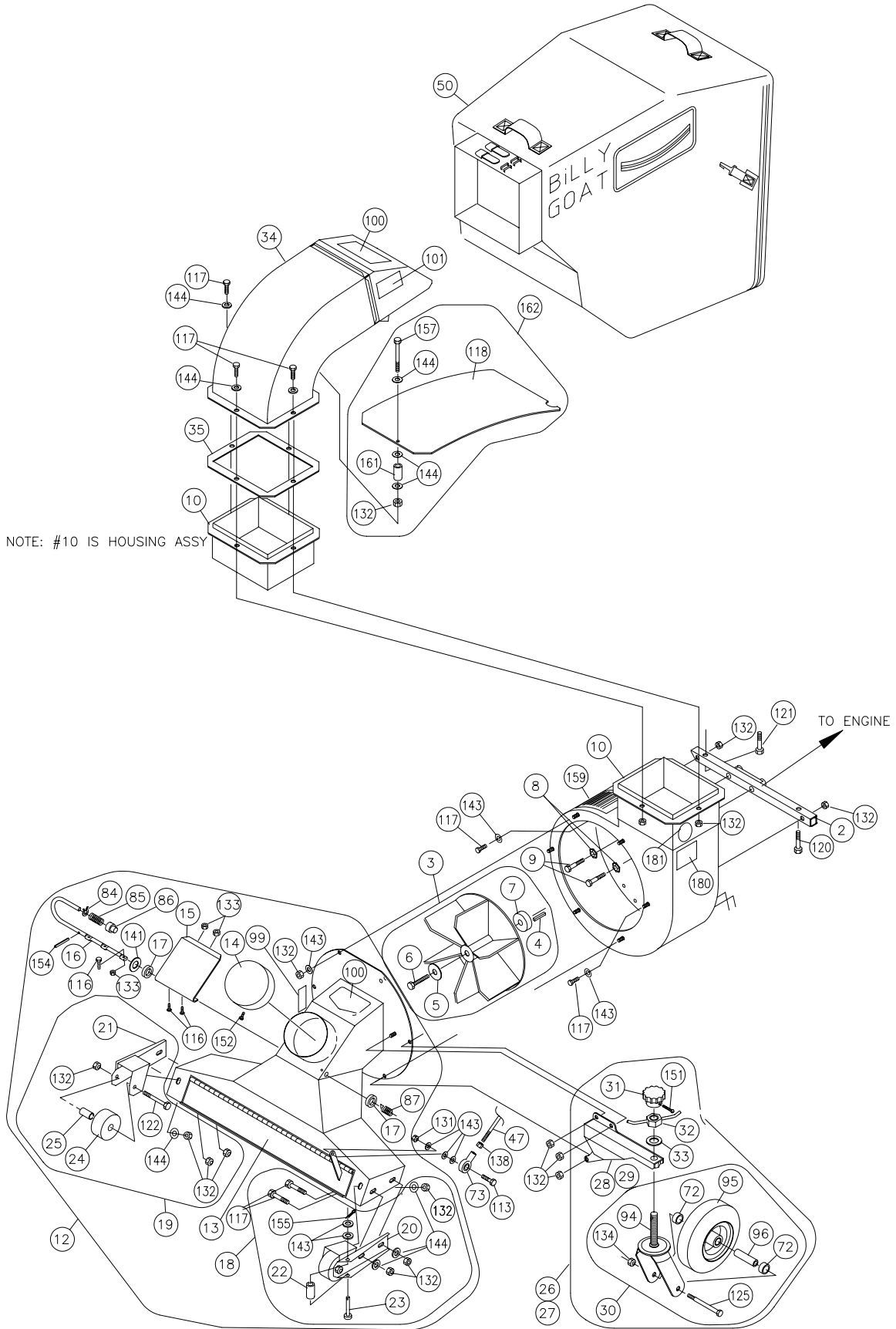

NOTE: #10 IS HOUSING ASSY

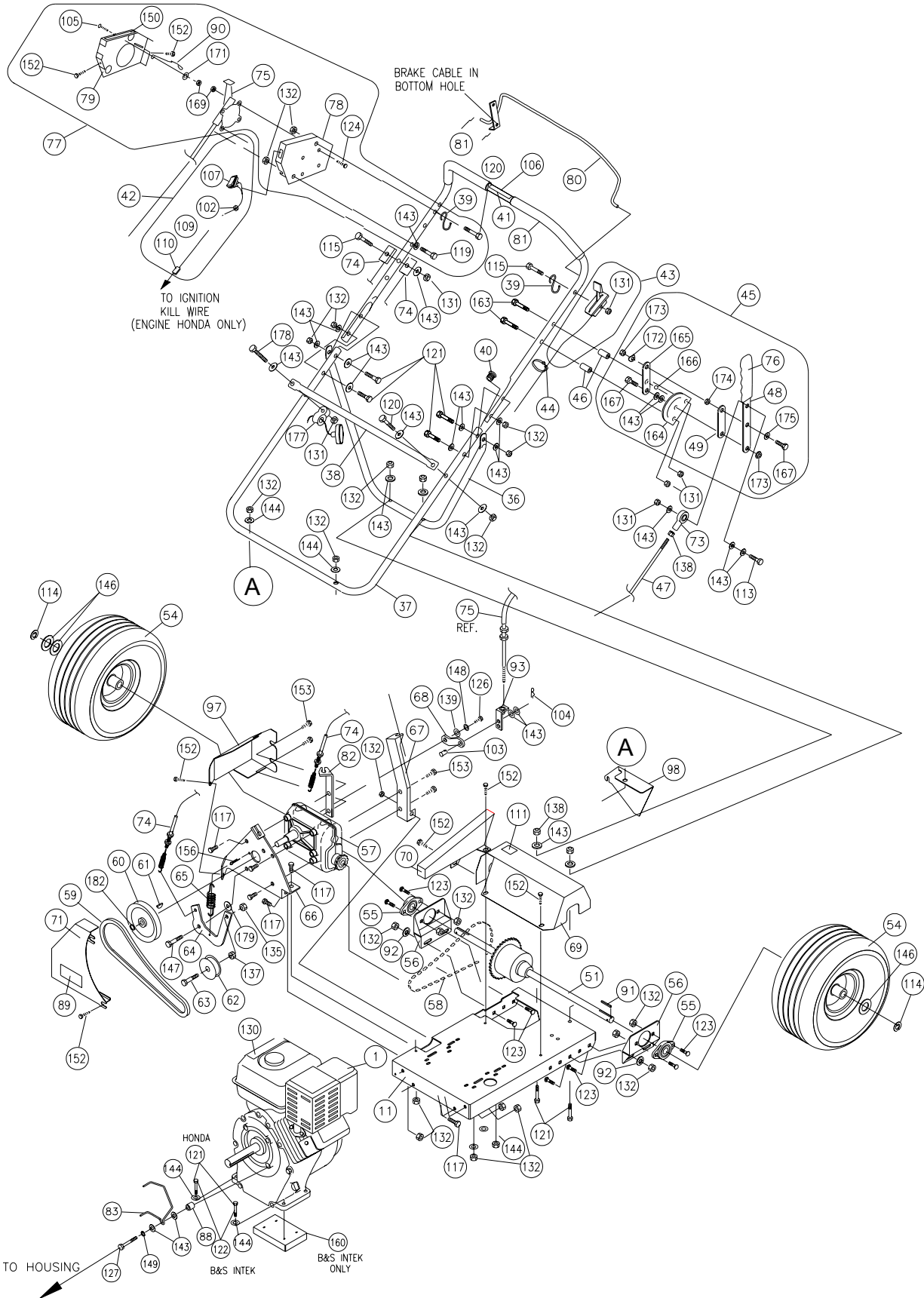



VQ Owner's Manual

PARTS LIST

ITEM	DESCRIPTION	VQ1002SP PART NO.	QTY	VQ902SPH PART NO.	QTY
1	ENGINE 10 HP INTEK B&S	430352	1	-	-
	ENGINE 9 HP HONDA	-	-	430287	1
2	ANGLE MOUNT HDLE WA	830126	1	830126	1
3	IMPELLER ASSY VQ (INCLUDES ITEM 4,5,6,7)	830244	1	830244	1
4	KEY 0.25 SQ. X 2.75"	9201125	1	9201125	1
5	WASHER LOCK 7/16 TWISTED TOOTH	850132	1	850132	1
6	SCREW CAP 7/16 NF x 2 1/4 GR8 TORQ 55-60 FT LBS (75-81 N.m)	830114	1	830114	1
7	SPACER ENGINE	830113	1	830113	1
8	WASHER LOCK 5/16 TWISTED TOOTH	800177	2	800177	2
9	SCREW CAP 5/16 NF x 2 1/2 GRD. 8	830136	2	830136	2
10	HOUSING ASSEMBLY W/LABELS VQ	830153	1	830153	1
11	FRAME WA VQ	830171	1	830171	1
12	NOZZLE ASSEMBLY VQ	830010	1	830010	1
13	NOZZLE ASSY W/LABELS	830181	1	830181	1
14	CAP PLUG VQ	830232	1	830232	1
15	PLATE DOOR NOZZLE HOSE	830193	1	830193	1
16	ROD DIVERTER VQ	830194	1	830194	1
17	GROMMET FLG. 1/2 MOLDED	830176	2	830176	2
18	BRKT BOGIE ASSY LH	830197	1	830197	1
19	BRKT BOGIE ASSY RH	830198	1	830198	1
20	BRKT BOGIE WA LH	830199	1	830199	1
21	BRKT BOGIE WA RH	830200	1	830200	1
22	ROLLER GUIDE	850204	2	850204	2
23	PIN ROLLER	850205	2	850205	2
24	WHEEL BOGIE 3"	850149	2	850149	2
25	SPACER 5/16 X 1 5/8	850150-03	2	850150-03	2
26	CASTER & BRKT LH ASSY SEMI-PNEUVQ	830540	1	830540	1
27	CASTER & BRKT RH ASSY SEMI-PNEUVQ	830541	1	830541	1
28	BRKT LH WA 8" CASTER	830147	1	830147	1
29	BRKT RH WA 8" CASTER	830148	1	830148	1
30	CASTER ASSY 8" SEMI-PNEU 3/4 NC (INCL ITEM 33 (4), 94, 95, 96, 125, 134)	830539	2	830539	2
31	KNOB HAND	850154	2	850154	2
32	NUT WING WA	800227	2	800227	2
33	WASHER 3/4 NYLON	800109	2	800109	2
34	ELBOW ASSY W/LABELS VQ	830159	1	830159	1
35	GASKET FLANGE TRANSITION VQ	830160	1	830160	1
36	HANDLE BRACE REAR	830162	1	830162	1
37	HANDLE LOWER VQ	830161	1	830161	1
38	TUBE HANDLE BAG SUPPORT	830163	1	830163	1
39	ROD BAG LOOP	800178	2	800178	2
40	CAP TUBE	800392	2	800392	2
41	HANDLE ASSY UPPER W/GRIP (39, 45, 46, 81, 114, 115, 131, 163)	890295-S	1	890295-S	1
42	SWITCH & WIRE ASSY (ITEMS 107,109,110)	-	-	830242	1
43	CONTROL THROTTLE ASSY VQ SERVICE	900514-00	1	830132	1
44	TY WRAP	900407	5	900407	5
45	DOOR NOZZLE FRICTION ASSY	830288	1	830288	1
46	SPACER	850198	2	850198	2
47	ROD DOOR NOZZLE	830286	1	830286	1
48	BAR LEVER DOOR	850189	1	850189	1
49	PLATE FRICTION LIFT	850191	1	850191	1
50	BAG ASSY VQ / TURF BAG 830313	830301	1	830301	1
51	AXLE REAR WA PUSH	-	-	-	-
	DIFFERENTIAL ASSY / SPROCK. ONLY 830021	830014	1	830014	1
52					
53					
54	WHEEL 13" x 6.5" PNEU. SP	830177	2	830177	2
55	BRG ASSY VQSP	850232	2	850232	2
56	BRKT MOUNT BEARING	830530	2	830530	2
57	TRANSMISSION 5 SPEED 1 REV W/BRAKE (TECUMSEH)	830179	1	830179	1
58	CHAIN #41 x 68P VQSP	830020	1	830020	1
59	BELT "V" 4L x 34" OUTSIDE LG.	830223	1	830223	1
60	PULLEY 5.0 DIA. A SEC 0.625 ID	830180	1	830180	1
61	KEY HIPRO 3/16 X 3/4	850234	1	850234	1
62	PULLEY IDLER	800260	1	800260	1
63	BOLT IDLER	800888	1	800888	1
64	ARM IDLER WA VQ	830527	1	830527	1
65	SPRING	400217	1	400217	1



VQ Owner's Manual

ITEM	DESCRIPTION	VQ1002SP PART NO.	QTY	VQ902SPH PART NO.	QTY
66	BRKT TRANSMISSION WA VQ	830222	1	830222	1
67	BRKT TRANSMISSION REAR WELD LONG	830520	1	830520	1
68	BAR LINK SHIFT OFFSET VQ	830508	1	830508	1
69	GUARD DIFFERENTIAL VQ WELD	830253	1	830253	1
70	GUARD CHAIN VQ WELD	830231	1	830231	1
71	GUARD PULLEY W/LABEL	830252	1	830252	1
72	SPACER 3/4" x 0.421"	830537	4	830537	4
73	ROD END BALL JOINT 5/16 NF	400873	2	400873	2
74	CABLE CLUTCH ASSY	830210	2	830210	2
75	CONTROL SHIFT	830504	1	830504	1
76	GRIP	840191	1	840191	1
77	CONTROL ASSY VQSP	830518	1	830519	1
78	BRACKET CONTROL SHIFT	830505	1	830505	1
79	COVER CONTROL SHIFT	830506	1	830506	1
80	ROD BAIL CLUTCH	830235	1	830235	1
81	GRIP HANDLE 1" x 16"	830166	2	830166	2
82	BAR BRAKE CABLE MOUNT	830225	1	830225	1
83	WIRE BELT GUIDE VQ	830133	1	830133	1
84	GRIP RING	400340	1	400340	1
85	SPRING COMPRESSION	400332	1	400332	1
86	SPACER	400330	1	400330	1
87	SPRING DOOR	890142	1	890142	1
88	SPACER			830134	1
89	LABEL DANGER GUARDS	900327	1	900327	1
90	WIRE STOP GEAR SELECTOR	830507	1	830507	1
91	KEY SQ 3/16 X 1 3/4	9201084	2	9201084	2
92	WASHER 5/16 TWISTED TOOTH	800177	4	800177	4
93	CLIP ASSY GEAR SELECTOR	830512	1	830512	1
94	FORK CASTER 8" 3/4 NC	830142	2	830142	2
95	WHEEL & TIRE ASSY 8",3/4" BRG. (SEMI- PNEU)	830538	2	830538	2
96	SPACER SPANNER	830144	2	830144	2
97	GUARD BRAKE VQ WELD	830250	1	830250	1
98	GUARD BELT VQ	830544	1	830228	1
99	LABEL DIVERTER INSTRUCTIONS	830196	1	830196	1
100	LABEL DANGER	400424	2	400424	2
101	LABEL DANGER FLYING MATERIAL	810736	2	810736	2
102	GROMMETT	-	-	830515	1
103	PIN CLEVIS	830513	1	830513	1
104	PIN HAIR	900471	1	900471	1
105	SCREW MACH FLAT HD PHILLIP #10-24 X 1/2	830514	1	830514	1
106	LABEL CLUTCH VQ	830503	1	830503	1
107	SWITCH ROCKER	-	-	500281	1
108					
109	HARNESS ENGINE KILL 33"	-	-	890442	1
110	CONNECTOR TAP	-	-	810673	1
111	LABEL OIL	830502	1	830502	1
112					
113	SCREW CAP 1/4-20 x 1 1/4"	*8041007	2	*8041007	2
114	RING RETAINING "E" 3/4	850230	2	850230	2
115	SCREW CAP 1/4-20 x 2"	*8041010	2	*8041010	2
116	SCREW CAP MACH 10-18X3/4 WF ZP	*8059136	3	*8059136	3
117	SCREW CAP 5/16-18 x 3/4"	*8041026	20	*8041026	20
118	PLATE DEBRIS DEFLECTOR	830279	1	830279	1
119	SCREW CAP 5/16-18 x 1 1/4"	*8041029	1	*8041029	1
120	SCREW CAP 5/16-18 x 1 1/2	*8041030	3	*8041030	3
121	SCREW CAP 5/16-18 x 1 3/4"	*8041031	11	*8041031	11
122					
123	BOLT CARRIAGE 5/16-18 X 3/4	*8024039	8	*8024039	8
124	SCREW #10-24NC X 5/8 HEX	*8059135	4	*8059135	4
125	SCREW CAP 1/2-10 x 4 1/2"	*8041107	2	*8041107	2
126	SCREW CAP 1/4 NF x 1/2 GR. 5"	850408	1	850408	1
127	SCREW CAP 5/16 NF x 1 3/4"	430412	1	430412	1
128					
129					
130	LABEL DO NOT FILL WHEN ENGINE IS HOT	400268	1	400268	1
131	NUT LOCK 1/4 NC	*8160001	7	*8160001	7
132	NUT LOCK 5/16 NC	*8160002	50	*8160002	50
133	NUT LOCK 10-24	8155007	3	8155007	3
134	NUT LOCK 1/2 NC	*8160005	2	*8160005	2
135	NUT LOCK 3/8 NC THIN HT.	*8161042	1	*8161042	1
136					
137	NUT REG. 3/8 NC	*8142003	2	*8142003	2



VQ Owner's Manual

ITEM	DESCRIPTION	VQ1002SP PART NO.	QTY	VQ902SPH PART NO.	QTY
138	NUT REG. 5/16 NF	*8149002	4	*8149002	4
139	WASHER SAE 1/4	*8172007	1	*8172007	1
140	WASHER SAE 5/16	8172008	3	8172008	3
141	WASHER SAE 3/8	*8172009	1	*8172009	1
142					
143	WASHER FLAT CUT 1/4	*8171002	40	*8171002	40
144	WASHER FLAT CUT 5/16	*8171003	19	*8171003	19
145					
146	WASHER 3/4 (0.765 x 1.25 x 0.06)	850238	3	850238	3
147	BOLT SHOULDER 3/8 X 3/4"	360184	1	360184	1
148	WASHER LOCK 1/4	*8177010	1	*8177010	1
149	WASHER LOCK 5/16	*8177011	1	*8177011	1
150	LABEL SPEED CONTROL	830237	1	830237	1
151	SCREW MACH #10-24 x 2"	*8059143	2	*8059143	2
152	SCREW SHT. MTL 1/4 AB x 3/4	*8122082	9	*8122082	9
153	SCREW SELF-TAP 5/16 NC x 3/4 HEX	*8123128	4	*8123128	4
154	PIN ROLL 1/8 x 3/4	*8195100	1	*8195100	1
155	PIN COTTER 3/32 x 3/4	*8197016	2	*8197016	2
156	PIN COTTER 1/8 x 1"	*8197031	1	*8197031	1
157	SCREW CAP 5/16-18 x 2 3/4	*8041035	1	*8041035	1
158	LOOSE PARTS BAG ASSY VQ	830204	1	830204	1
159	LABEL DANGER INSTRUCTIONS	830138	1	830138	1
160	SPACER ENGINE INTEK	430355	1	-	-
161	SPACER	900724	1	900724	1
162	DEFLECTOR DEBRIS ASSY	830280	1	830280	1
163	SCREW CAP 1/4-20 x 2"	8041009	2	8041009	2
164	PLATE QUAD LIFT	850192	1	850192	1
165	PLATE CLAMP LIFT	850193	1	850193	1
166	BALL 1/4"	850194	1	850194	1
167	SCREW CAP 1/4-20 x 1"	8041006	2	8041006	2
168					
169	NUT LOCK #10-24 NC LT	*8164005	5	*8164005	5
170					
171	WASHER #10 FLAT SAE	*8172005	1	*8172005	1
172	WASHER - BELVILLE 1/4"	850207	1	850207	1
173	NUT LOCK 1/4-20	8160001	2	8160001	2
174	NUT JAM 1/4-20	8143001	1	8143001	1
175	WASHER LOCK - EXT 1/4	*8181007	1	*8181007	1
176					
177	GUIDE STARTER ROPE	830533	2	830533	2
178	SCREW CAP 1/4 - 20 x 2 1/4	*8041011	1	*8041011	1
179	WASHER SHIM 0.020"	890131	1	890131	1
180	LABEL EAR EYE BREATHING	890254	1	890254	1
181	LABEL READ OWNER'S MANUAL	890301	1	890301	1
182	SNAP RING	850233	1	850233	1

SWITCH AND WIRE ASSEMBLY PARTS LIST

(HONDA SP ONLY)

107	SWITCH TOGGLE 6A/125V	500281	1
109	HARNESS ENGINE KILL 33"	890442	1
110	CONNECTOR TAP IN SQUEEZE	810673	1
E-1	WIRE TO ENGINE STOP SWITCH	-----	-

BL	BLACK
Y	YELLOW
G	GREEN

