

PARTS PRICE LIST

for
Tucker® POLE WINDOW WASHER and
EXTERIOR MAINTENANCE SYSTEMS

LIST PRICING

Effective January 1, 2008

REPLACEMENT HANDLE SECTIONS

Each section includes one (1) handle clamp.
All top sections are universal, being equipped and drilled for either single or dual hose.

PART #	3.4 or 6 foot lengths	PART #	12 foot length sections		
1/3, 1/4, 1/6	Top #1 section \$ 51.47	2/12	#2 section	\$	89.54
2/3, 2/4, 2/6	#2 section \$ 53.32	3/12	#3 section	\$	96.39
3/3, 3/4, 3/6	#3 section \$ 56.29	4/12	#4 section	\$	99.41
4/4 or 4/6	#4 section \$ 59.63	5/12	#5 section	\$	105.74
5/4 or 5/6	#5 section \$ 63.44	6/12	#6 section	\$	110.39
6/6	#6 section \$ 69.52	7/12	#7 section or #7 slide	\$	117.15
7/6	#7 section \$ 74.19	8/12	#8 section or mid #8	\$	124.59
8/6	#8 section \$ 89.87	1C - 8C	Handle Clamps	\$	6.45
1BR - 8BR	Butt Rings \$ 5.80	Rivet 2	Rivet for Clamps	\$	0.52
BRS	Butt Ring Screw \$ 0.69				

Note: Give handle size or section number for handle clamps or butt rings. Universal for two, three, four, six and twelve foot lengths.

Labor for reconditioning and reslotting each handle section R-H \$ 8.25 ea.***
No distributor discount

PART #	REPLACEMENT WINDOW WASHER HOSE	FITTINGS	
SH	Single hose cut to length \$ 1.05 per foot +	\$ 7.39	**
DH	Dual Hose cut to length \$ 1.21 per foot +	\$ 14.56	**

Please specify replacement or extension fittings when ordering replacement hose

211	Garden Hose Adaptor (short)	\$	8.82
211L	Garden Hose Adaptor for single hose	\$	8.82
411	Dual Hose Adaptor (for ADH method)	\$	18.89
500	Hose Ferrule	\$	0.78
501	Hose Insert and Female Swivel (brass)	\$	2.70
501N	Hose Insert and Female Swivel (nylon)	\$	2.37
502-4	Hose Insert and Male Thread 1/4"	\$	2.37
502-8	Hose Insert and Male Thread 1/8"	\$	2.37
503	1/4" Hose Gasket (pkg. of 6)	\$	1.46
GHG	Garden Hose Gasket (pkg. of 6)	\$	1.46
DITQC14	Brass Quick Connect 1/4"	\$	9.38
DITQC34	Brass Quick Connect- Garden Hose 3/4"	\$	10.56
MINIQC	Mini Brass Quick Release Handle Set (for Single Hose only)	\$	23.29

REPLACEMENT BRUSHES AVAILABLE

	PART#	W/O HEAD	PART#	W/HEAD
12" Standard Double Trim Window Brush	12DT	\$ 50.46	12DTH	\$ 62.60
12" Full Trim Window Brush	12FT	\$ 51.81	12FTH	\$ 64.34
12" Full Trim Awning Brush	12AT	\$ 51.81	12ATH	\$ 64.64
12" Full Trim Plexiglass Brush	12PG	\$ 54.29	12PGH	\$ 66.83
12" Full Trim Rough Surface Brush	12RS	\$ 54.91	12RSH	\$ 67.45
12" Foam Center Window Brush	12FC	\$ 51.81	12FCH	\$ 64.34
12" Foam Center Interior Wall Brush	12FCI	\$ 51.81	12FCIH	\$ 64.34
18" Double Trim Window Brush	18DT	\$ 100.19	18DTH	\$ 115.70
18" Full Trim Window Brush	18FT	\$ 101.37	18FTH	\$ 116.71
18" Full Trim Awning Brush	18AT	\$ 101.37	18ATH	\$ 116.71
18" Full Trim Plexiglass Brush	18PG	\$ 104.04	18PGH	\$ 119.38
18" Full Trim Rough Surface Brush	18RS	\$ 104.71	18RSH	\$ 120.05
18" Foam Center Window Brush	18FC	\$ 71.04	18FCH	\$ 86.38
9" Double Trim Window Brush	9DT	\$ 53.73	9DTH	\$ 66.73
9" Full Trim Window Brush	9FT	\$ 53.73	9FTH	\$ 66.73
6" Double Trim Window Brush		only available with head	6DTH	\$ 65.58
6" Full Trim Window Brush		only available with head	6FTH	\$ 65.58
Small Round Brush		only available with head	SRBRH	\$ 65.58
		For Special Order Brushes:	Foam Center only-12"	FC-12 \$ 8.34
			Foam Center only-18"	FC-18 \$ 10.54

Surcharges for special requests are typically \$10.00 for 12" brushes and \$15.00 for 18" brushes with *** no distributor discount.***

PART #	DETERGENT DISPENSERS	
B	B Method (single hose)	\$ 114.39
C	C Method (dual hose)	\$ 97.05
	Labor for reconditioning and rebuilding dispensers	\$ 20.00 ***
	No distributor discount	

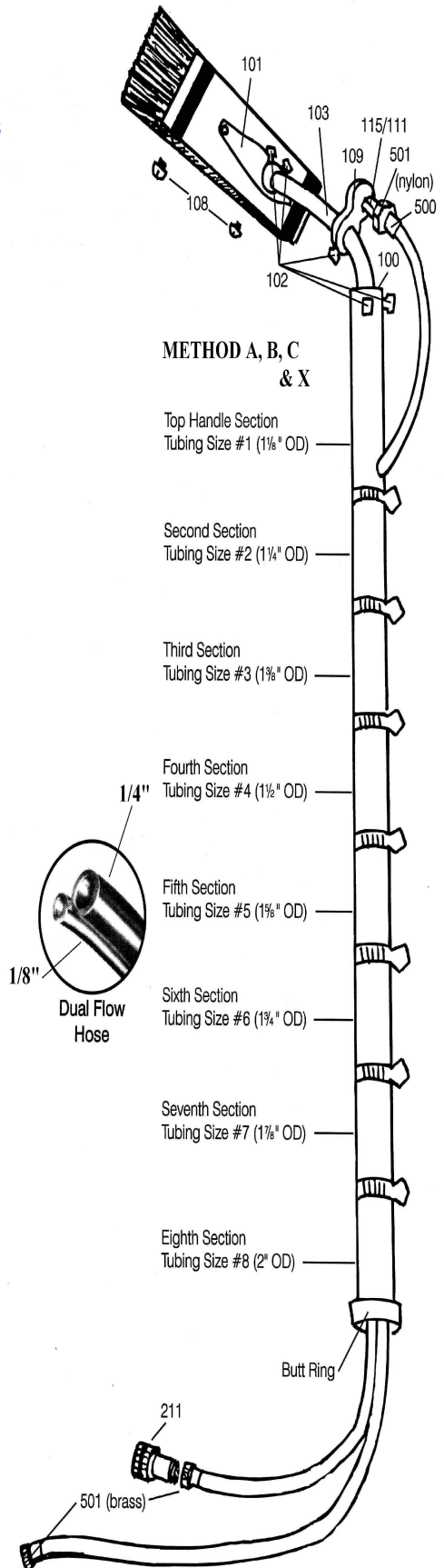

Tucker® Single (SH) hose size is 1/4".

Standard Hose Sizes for Dual Hose:
C Rinse use 1/4". X Rinse uses 1/8" hose.

DEMA® LIQUID INJECTOR PARTS			
DIC	Dema Injector Valve Assembly Complete	\$	121.46 *
TIPKIT	Dema Plastic Tip Kit	\$	13.35
TIP	Standard Dema Replacement Plastic Tip	\$	2.14
DEMA01	Dema Injector Valve (clear hose included)	\$	87.69
D32	Dema Meter Knob (brown piece)	\$	13.67
D33	Dema Meter Knob Screws	\$	0.87
208	Valves-All Models	\$	20.09
209	Tee-B and C methods (inlet)	\$	7.91
211	Garden Hose Adaptor (short)	\$	8.82

See Complete Dema Injector Valve Assembly diagram on other page.

* 1/4" hose is needed for liquid detergent dispenser.

C Detergent/brush uses 1/8" hose.
X Detergent/brush uses 1/4" hose.

All Prices are listed in US Dollars. Subject to change without notice. Freight terms: Ex-Works Cedar Rapids, IA USA, or origin of shipment, shipping & handling charges prepaid and added to all invoices, with a minimum of \$10.50. Tucker Manufacturing Co., Inc. reserves the right to ship freight collect.

Tucker® is a Registered Trademark of Tucker Manufacturing Co., Inc., Cedar Rapids, Iowa, USA.
Dema® is a Registered Trademark of Dema Engineering.

- OVER -

2008abcxpps

© TMCO 2008

Parish-Supply.com
Syracuse, NY 315-433-9031
parish-supply.com



PART#	GOOSENECKS	Single Hose	PART#	Dual Hose
103	Standard 8 inch Gooseneck	\$ 3.40	103	\$ 3.40
103-12	Gooseneck of 9" to 12 inches	\$ 3.65	103-12	\$ 3.65
103-24	Gooseneck of 13 to 24 inches	\$ 7.50	103-24XS	\$ 18.55 *
103-36	Gooseneck of 25 to 36 inches	\$ 10.90	103-36XS	\$ 19.95 *

Extended Special Gooseneck With Bracket (24" to 36")

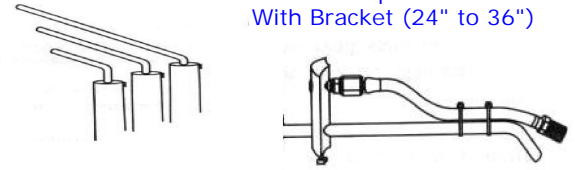

#103 Gooseneck 8" - 36"

* Extended Special Gooseneck with rinse bracket and #111 jet rinse nozzle
The #115 PVC or #118 Brass Fan Spray Nozzles can be purchased separately.

PART#	MISCELLANEOUS PARTS		
100	Gooseneck Ferrule only	\$	3.07
101	Replacement Head (9" & 12" Brushes)	\$	15.00 *
101H	Replacement Head (X method pole)	\$	16.07 *
1801	Replacement Head (18" brushes)	\$	17.12 *
	* Includes 2-102 & 1-#110		
01	Replacement Head (single outlet)	\$	6.15
102	Square Head Set Screw	\$	0.94
106	C Method Extended Rinse Bracket only	\$	4.39
108	Brush Screw (not included with head)	\$	1.83
108L	Long Brush Screw (not included with head)	\$	2.88
108S	Special Brush Screw (not included w/ head)	\$	2.88
109	C Method Rinse Bracket only	\$	4.22
110	Brass Nipple (brush to gooseneck)	\$	1.48
111	Nylon Jet Rinse Nozzle (white)	\$	2.08
115	PVC Fan Spray Nozzle (gray)	\$	18.15
118	Brass Fan Spray Nozzle	\$	19.95
TT	Tucker® Pole Tool	\$	14.95
TTH	Tucker Tool Holster	\$	5.95
DIY001	TDI Y connect (see diagram on page)	\$	22.99
DITDS	Hand Held TDS Meter	\$	43.85
DITVP002	Valve On The Pole	\$	93.84
TVP00C	Valve On The Pole, Retrofit Kit	\$	109.53
VH	Valve Holster	\$	10.93
V1	DVD - "Tucker® Pole Systems"	\$	10.55
2001TA	2001 Series Valve Connectors	\$	52.06 and up
12VBPPUMP	12 Volt By-Pass Pump	\$	164.13 and up

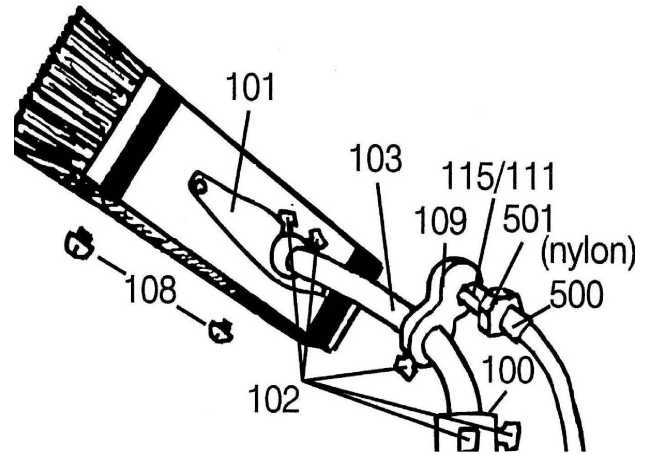

B TYPE DISPENSER

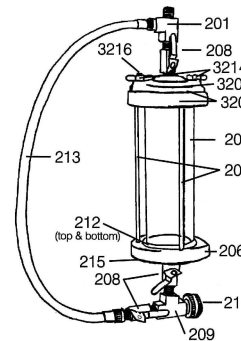

COMPLETE DEMA INJECTOR VALVE ASSEMBLY

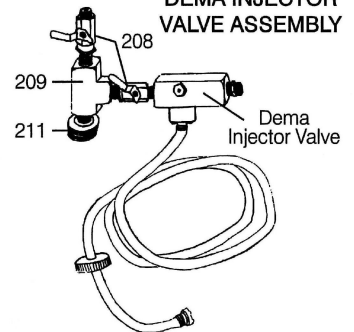

C TYPE DISPENSER

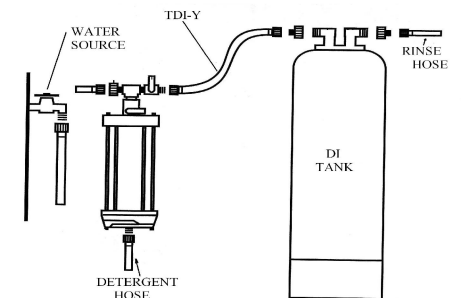
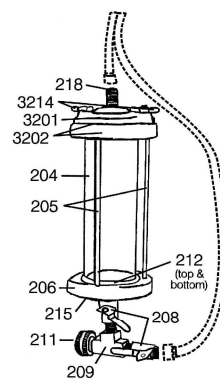

PART#	DETERGENT DISPENSER PARTS		
200	Adapter- 1/8" to 1/4"	\$	1.77
201	Tee-B Dispenser Only (outlet)	\$	12.50
202	Closed Nipple 1/4"	\$	1.16
203	Lid Gasket-All Models	\$	0.87
204	Sight Tube-All Models	\$	10.56
205	Tension Rod	\$	1.46
206	Inlet-All Models	\$	10.42
208	Valves-All Models	\$	20.90
VHANDLE	Valve Handles w/ screws & washer	\$	1.22
209	Tee-B and C methods (inlet)	\$	7.91
211	Garden Hose Adaptor (short)	\$	8.82
211L	Garden Hose Adaptor for single hose	\$	8.82
212	Molded Sight Tube Gasket	\$	2.38
213	By-Pass Hose- B Dispenser Only	\$	8.34
215	Tension Nut	\$	0.92
218	Outlet Fitting - C Dispenser Only	\$	2.37
300	Inlet Valve Assembly-All Models	\$	59.37
3201	Dispenser Lid Only	\$	7.39
3202	Outlet Ring and Lid-All Models	\$	13.19
3214	Wing Nut- All Models	\$	0.76
3216	Brass Stud- All Models	\$	0.87

PART#	WATER TREATMENT for use with Tucker® Pole System		
RO	Reverse Osmosis Systems (ie: 1000 gallon per day)		Call for pricing
DITDI835	835 DI Tank System 8" x 35" (other sizes available)	\$	594.00
DITDI420C	420 DI Cartridge System 4.5" x 20"	\$	459.00
DIC-20-4.5	Replacement Cartridges for DI Cartridge System	\$	167.40
DIQD3	DI Tank Head Assembly for 835 DI Tank	\$	61.72
DIREGIN	Regeneration of DITDI835 DI Tank System	\$	90.00 and up ***
	*** Includes 7.5% environmental fee (no distributor discount on 7.5%)		



LIQUID CLEANING PRODUCTS

* AWNING CLEANER/PROTECTANT	
CPC - Case (4-1 Gal.)	\$ 149.42
CPP - PAIL (5 Gal.)	\$ 176.61
* DEEP CLEAN	
DDC - Case (4-1 Gal.)	\$ 162.72
DDP - Pail (5 Gal.)	\$ 216.08
* AWNING AND FABRIC SPOTTER	
FSC - Case (4-1 Gal.)	\$ 157.08
FSP - Pail (5 Gal.)	\$ 185.91
** AWNING ARMOR	
AAC - Case (4-1 Gal.)	\$ 268.70
AAP - Pail (5 Gal.)	\$ 318.25
** AWNING GUARD 690 PLUS	

WINDOW WASHING DETERGENT TABLETS

1LB - 1 pound (454 gr.) plastic lugs	\$ 9.32 ea.
2/11 - when you order 2 - 11 per shipment	\$ 6.66 ea.
C12 - Case of 12 one pound lugs	\$ 66.58 cs.
C24 - Case of 24 one pound lugs	\$ 127.58 cs.

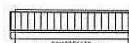

C36 - Case of 36 one pound lugs
 6LB - 6 pound (2.724 gr.) plastic tubs
 C4 - Case of 4 (6 pound tubs)
 Bulk Detergent
 25LB - 25 lb in bulk pack

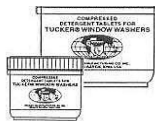

\$ 183.28 cs.
 \$ 34.32 ea.
 \$ 123.78 cs.
 \$ 110.19 ctn.

AGC - Case (4-1 Gal.) \$ 229.33
 AGP - Pail (5 Gal.) \$ 271.45
 ** X-TRA SHINE
 XSC - Case (4-1 Gal.) \$ 275.49
 XSP - Pail (5 Gal.) \$ 326.04

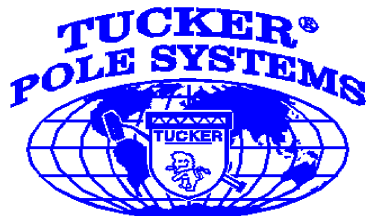

Parish-Supply.com
 Syracuse, NY 315-433-9031
 parish-supply.com

